

Property of WolfVision GmbH (Ltd.)
 Reproduction, copy, or any kind of
 duplication of all or partial contents, is strictly
 prohibited without prior consent of the proprietor.

Eigentum der Fa. WolfVision GmbH
 Nachdruck, kopieren oder jede sonstige Art der
 Vervielfältigung des gesamten oder teilweisen Inhalts,
 ist ohne die Genehmigung des Eigentümers nicht erlaubt!

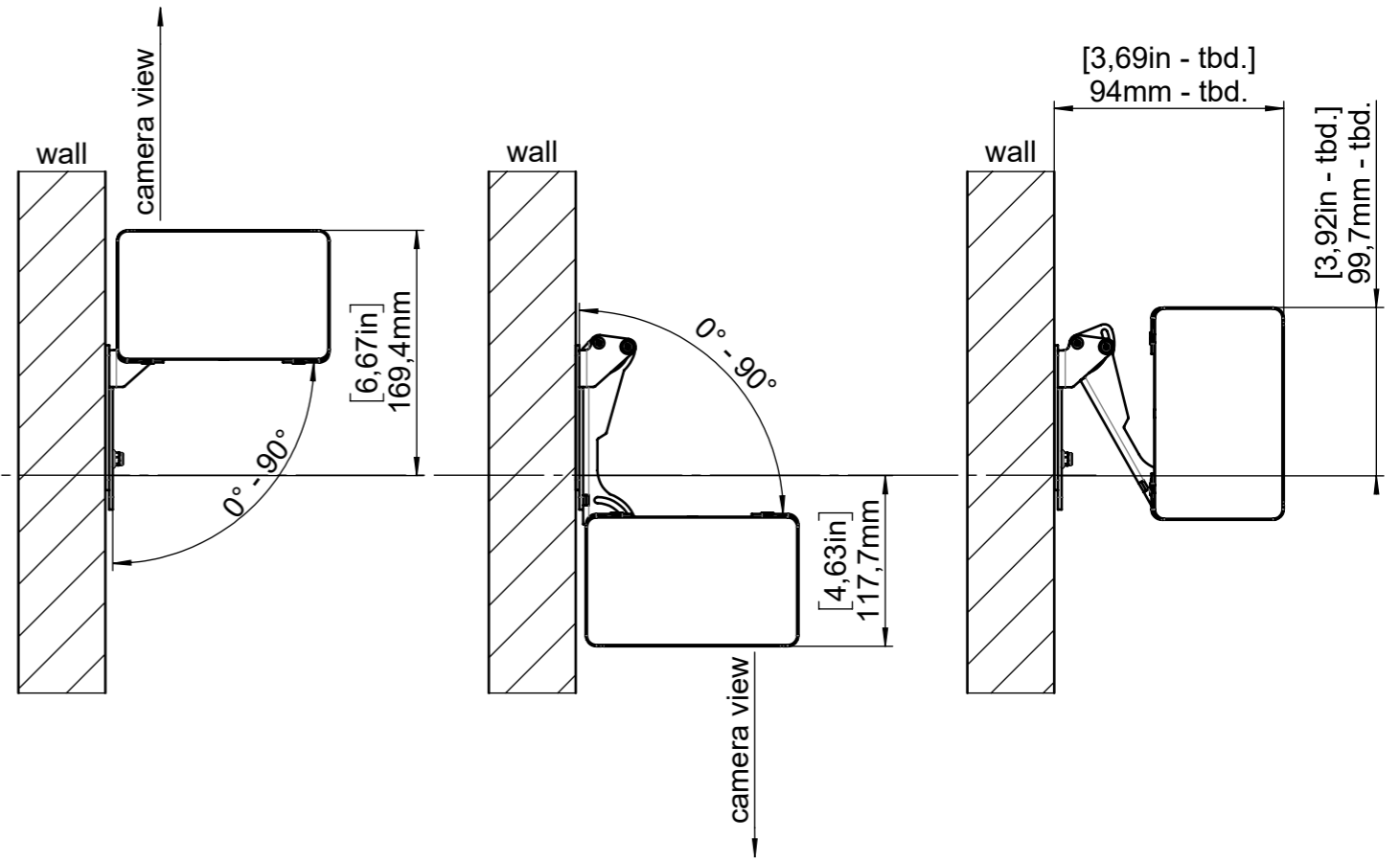

DETAIL CONNECTORS
 M 1:2.5

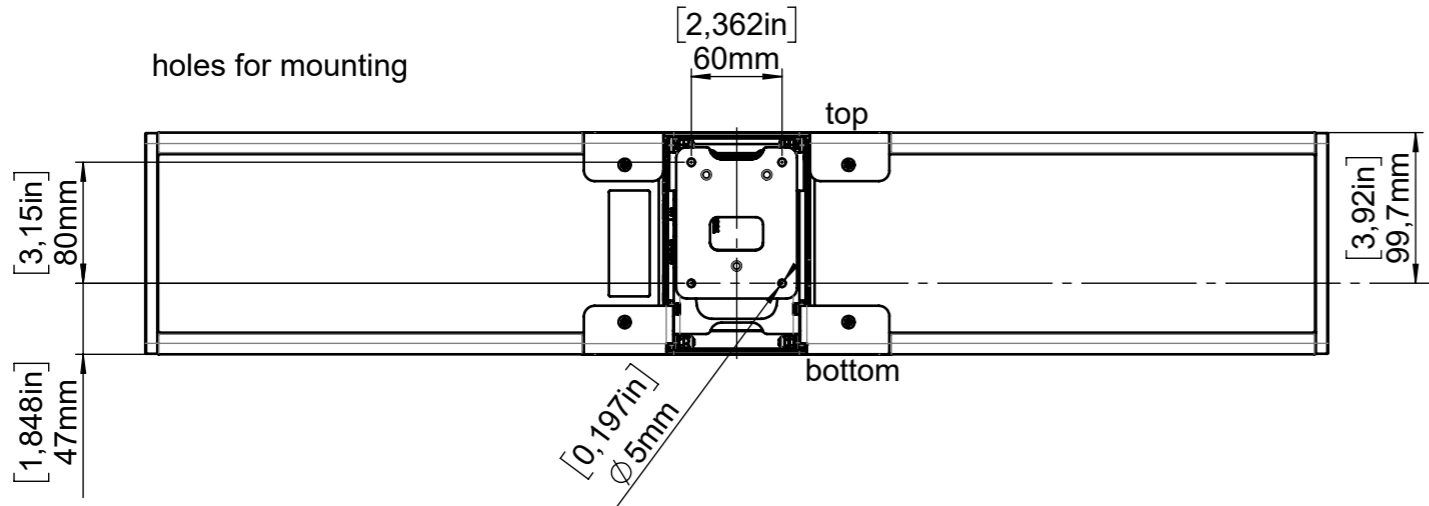
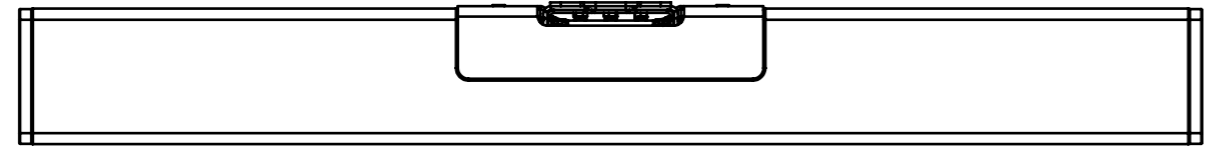
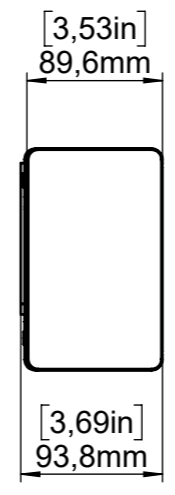
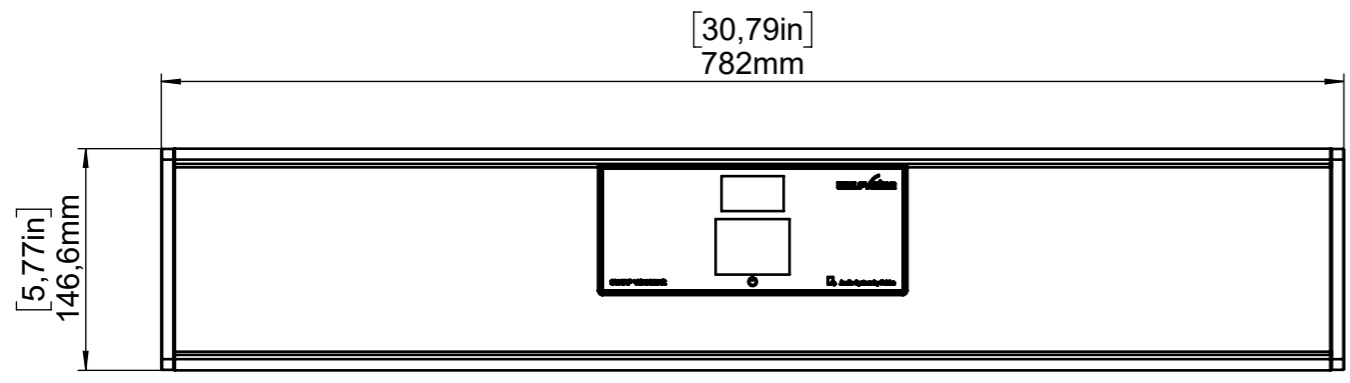
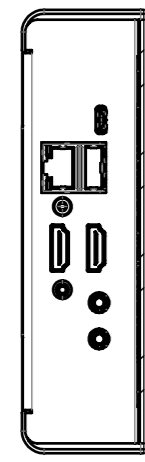

view to the left

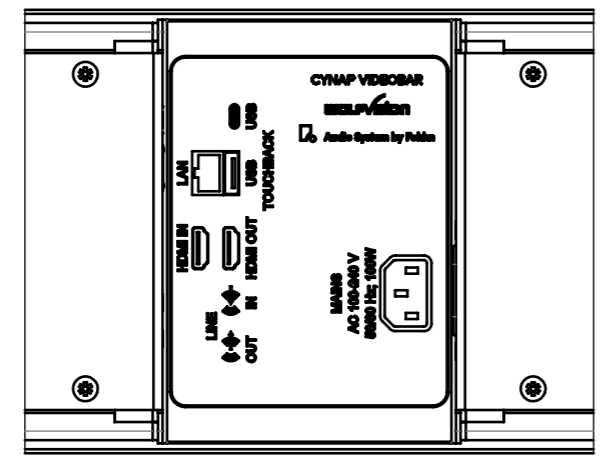

view to the right

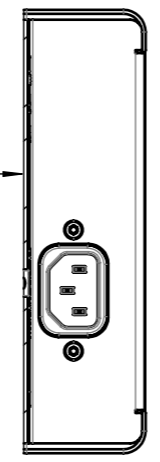

| | | | | | | | | |
|--------------|----|---|------------|--|-----------|-----------|-------------------|----------|
| | | WolfVision GmbH Oberes Ried 14 A-6833 Klaus/ Austria Tel.: ++43(0)5523/52250-0 Fax.: ++43(0)5523/52249 Mail: wolfvision@wolfvision.com www.wolfvision.com | | Alle Maße ohne Oberflächenbeschichtung! Artikel Nr.: 117563 Benennung: Dimensions Videobar mm / [inch] | | DIN-Norm: | Datum: 23.04.2024 | Name: BO |
| | | Index: | Dok-Nr.: 4 | Maßstab: 1:5 | Erstellt: | Geprüft: | Serienfreig.: | |
| Freimaßtol.: | -- | Änd.-Antrag: | -- | Ersetzt: | -- | | | |
| Material: | -- | Rauigkeit: | Rz< | Seiten: | 1/1 | | | |